

► Horn Theory: An Introduction, Part 1

By Bjørn Kolbrek

This author presents a two-part introduction to horns—their definition, features, types, and functions.

This article deals with the theory of acoustical horns, as it applies to loudspeakers. It reviews the basic assumptions behind classical horn theory as it stands, presents the different types of horns, and discusses their properties. Directivity control, wave-front shapes, and distortion are also discussed.

In this article, I try to keep the math simple, and, where it is required, I explain or illustrate the meaning of the equations. The focus is on understanding what is going on in a horn. The practical aspects of horn design are not treated here.

TERMINOLOGY

The article includes the following terminology:

Impedance: Quantity impeding or reducing flow of energy. Can be electrical, mechanical, or acoustical.

Acoustical Impedance: The ratio of sound pressure to volume velocity of air. In a horn, the acoustical impedance will increase when the cross-section of the horn decreases, as a decrease in cross section will limit the flow of air at a certain pressure.

Volume Velocity: Flow of air through a surface in m^3/s , equals particle velocity times area.

Throat: The small end of the horn, where the driver is attached.

Mouth: The far end of the horn, which radiates into the air.

Driver: Loudspeaker unit used for driving the horn.

c: The speed of sound, 344m/s at 20° C.

ρ_0 : Density of air, 1.205 kg/m^3 .

f: Frequency, Hz.

ω : Angular frequency, radians/s, $\omega = 2\pi f$.

k: Wave number or spatial frequency,

radians/m, $k = \frac{\omega}{c} = \frac{2\pi f}{c}$.

S: Area.

p: Pressure.

Z_A : Acoustical impedance.

j: Imaginary operator, $j = \sqrt{-1}$.

THE PURPOSE OF A HORN

It can be useful to look at the purpose of the horn before looking at the theory. Where are horns used, and for what?

Throughout the history of electroacoustics, there have been two important aspects:

- Loading of the driver
- Directivity control

You would also think that increasing the output would be one aspect of horns, but this is included in both. Increasing the loading of the driver over that of free air increases efficiency and hence the output, and concentrating the sound into a certain solid angle increases the output further.

Loading of the Driver. The loudspeaker, which is a generator of pressure, has an internal source impedance and drives an external load impedance. The air is the ultimate load, and the impedance of air is low, because of its low density.

The source impedance of any loudspeaker, on the other hand, is high, so

there will be a considerable mismatch between the source and the load. The result is that most of the energy put into a direct radiating loudspeaker will not reach the air, but will be converted to heat in the voice coil and mechanical resistances in the unit. The problem is worse at low frequencies, where the size of the source will be small compared to a wavelength and the source will merely push the medium away. At higher frequencies, the radiation from the source will be in the form of plane waves that do not spread out. The load, as seen from the driver, is at its highest, and the system is as efficient as it can be.

If you could make the driver radiate plane waves in its entire operating range, efficient operation would be secured at all frequencies. The driver would work into a constant load, and if this load could be made to match the impedances of the driver, resonances would be suppressed. This is because the driver is a mechanical filter, which needs to be terminated in its characteristic impedance, ideally a pure resistance. If the driver is allowed to radiate plane waves, resistive loading is secured.

The easiest way to make the driver radiate plane waves is to connect it to a long, uniform tube. But the end of the tube will still be small compared to a wavelength at low frequencies. To avoid reflections, the cross section of the tube must be large compared to a wavelength, but, at the same time, it must also be

small to fit the driver and present the required load. To solve this dilemma, you need to taper the tube.

When you do this, you can take radiation from the driver in the form of plane waves and transform the high pressure, low velocity vibrations at the throat into low pressure, high velocity vibrations that can efficiently be radiated into the air. Depending on how the tube flares, it is possible to present a load to the driver that is constant over a large frequency range.

Directivity Control. The directivity of a cone or dome diaphragm is largely uncontrolled, dictated by the dimensions of the diaphragm, and heavily dependent on frequency, becoming sharper and sharper as frequency increases. You can solve this problem by using multiple driving units and digital signal processing, but a far simpler and cheaper way to achieve predictable directivity control is to use a horn. The walls of the horn will restrict the spreading of the sound waves, so that sound can be focused into the areas where it is needed, and kept out of areas where it is not.

Directivity control is most important in sound reinforcement systems, where a large audience should have the same distribution of low and high frequencies, and where reverberation and reflections can be a problem. In a studio or home environment, this is not as big a problem.

As the art and science of electroacoustics has developed, the focus has changed from loading to directivity control. Most modern horns offer directivity control at the expense of driver loading, often presenting the driver with a load full of resonances and reflections. **Figure 1** compares the throat impedance of a typical constant directivity horn (dashed line) with the throat impedance of a tractrix horn (solid line)¹. The irregularities above 8kHz come from higher order modes.

FUNDAMENTAL THEORY

Horn theory, as it has been developed, is based on a series of assumptions and simplifications, but the resulting equations can still give useful information about the behavior. I will review the assumptions later, and discuss how well they hold up in practice.

The problem of sound propagation in horns is a complicated one, and has not yet been rigorously solved analytically.

Initially, it is a three-dimensional problem, but solving the wave equation in 3D is very complicated in all but the most elementary cases. The wave equation for three dimensions (in Cartesian coordinates) looks like this²

$$\frac{\partial^2 \phi}{\partial t^2} - c^2 \left(\frac{\partial^2 \phi}{\partial x^2} + \frac{\partial^2 \phi}{\partial y^2} + \frac{\partial^2 \phi}{\partial z^2} \right) = 0 \quad (1)$$

This equation describes how sound waves of very small (infinitesimal) amplitudes behave in a three-dimensional medium. I will not discuss this equation, but only note that it is not easily solved in the case of horns.

In 1919, Webster³ presented a solution to the problem by simplifying equation 1 from a three-dimensional to a one-dimensional problem. He did this by assuming that the sound energy was uniformly distributed over a plane wave-front perpendicular to the horn axis, and considering only motion in the axial direction. The result of these simplifications is the so-called “Webster’s Horn Equation,” which can be solved for a large number of cases:

$$\frac{d^2 \phi}{dx^2} + \frac{d \ln S}{dx} \frac{d \phi}{dx} - k^2 \phi = 0 \quad (2)$$

where

$k = \frac{2\pi f}{c}$, the wave number or spatial frequency (radians per meter),

ϕ is the velocity potential (see appendix for explanation), and S is the cross-sectional area of the horn as a function of x .

The derivation of equation 2 is given in the appendix. You can use this equation to predict what is going on inside a horn, neglecting higher order effects, but it can’t say anything about what is going on outside the horn, so it can’t predict directivity. Here are the assumptions equation 2 is based on^{4,5}:

1. Infinitesimal amplitude: The sound pressure amplitude is insignificant compared to the steady air pressure. This condition is easily satisfied for most speech and music, but in high power sound reinforcement, the sound pressure at the throat of a horn can easily reach 150-170dB SPL. This article takes a closer look at distortion in horns due to the nonlinearity of air later, but for now it is sufficient to note that the distortion at home reproduction levels

is insignificant.

2. The medium is considered to be a uniform fluid. This is not the case with air, but is permissible at the levels (see 1) and frequencies involved.

3. Viscosity and friction are neglected. The equations involving these quantities are not easily solved in the case of horns.

4. No external forces, such as gravity, act on the medium.

5. The motion is assumed irrotational.

6. The walls of the horn are perfectly rigid and smooth.

7. The pressure is uniform over the wave-front. Webster originally considered tubes of infinitesimal cross-section, and in this case propagation is by plane waves. The horn equation does not require plane waves, as is often assumed. But it requires the wave-front to be a function of x alone. This, in turn, means that the center of curvature of the wave-fronts must not change. If this is the case, the horn is said to admit one-parameter (1P) waves⁶, and according to Putland⁷, the only horns that admit 1P waves are the uniform tube, the parabolic horn with cylindrical wave-fronts, and the conical horn. For other horns, you need the horn radius to be small compared to the wavelength.

Because the horn equation is not able to predict the interior and exterior sound field for horns other than true 1P horns, it has been much criticized. It has, however, been shown^{8,9} that the approximation is not as bad as you might think in the first instance. Holland¹⁰ has shown that you can predict the performance of horns of arbitrary shape by considering the wave-front area expansion instead of the physical cross-section of the horn. I have also developed software based on the same principles, and have been able to predict the throat impedance of horns with good accuracy.

SOLUTIONS

This section presents the solution of equation 2 for the most interesting horns, and looks at the values for throat impedance for the different types. You can calculate this by solving the horn equation, but this will not be done in full mathematical rigor in this article.

The solution of equation 2 can, in a

general way, be set up as a sum of two functions u and v :

$$\phi = Au + Bv \quad (3)$$

where A and B represent the outgoing (diverging) and reflected (converging) wave, respectively, and u and v depend on the specific type of horn.

In the case of an infinite horn, there is no reflected wave, and $B = 0$. This article first considers infinite horns, and presents the solutions for the most common types¹¹. The solutions are given in terms of absolute acoustical impedance,

$$\frac{\rho_0 c}{S_t} \quad ;$$

you can find the specific throat impedance (impedance per unit area) by multiplying by S_t , the throat area, and the normalized throat resistance by multiplying by $\frac{S_t}{\rho_0 c}$.

THE PIPE AND THE PARABOLIC HORN

Both these horns are true 1P horns. The infinite pipe of uniform cross-section acts as a pure resistance equal to

$$z_A = \frac{\rho_0 c}{S_t} \quad (4)$$

An infinite, uniform pipe does not sound very useful. But a suitably damped, long pipe (plane wave tube) closely approximates the resistive load impedance of an infinite pipe across a wide band of frequencies, and is very valuable for testing compression drivers^{12, 13}. It presents a constant frequency independent load, and as such acts like the perfect horn.

The parabolic horn is a true 1P horn if it is rectangular with two parallel sides, the two other sides expanding linearly, and the wave-fronts are concentric cylinders. It has an area expansion given as

$S = S_t x$. The expression for throat impedance is very complicated, and will not be given here.

The throat impedances for both the uniform pipe and the parabolic horn are given in **Fig. 2**. Note that the pipe has the best, and the parabolic horn the worst, loading performance of all horns shown.

CONICAL HORN

The conical horn is a true 1P horn in

spherical coordinates. If you use spherical coordinates, the cross-sectional area of the spherical wave-front in an axisymmetric conical horn is $S = \Omega(x+x_0)^2$, where x_0 is the distance from the vertex to the throat, and Ω is the solid angle of the cone. If you know the half angle θ (wall tangent angle) of the cone,

$$\Omega = 2\pi(1 - \cos\theta). \quad (5)$$

In the case where you are interested in calculating the plane cross-sectional area at a distance x from the throat,

$$s(x) = S_t \left(\frac{x+x_0}{x_0} \right)^2. \quad (6)$$

The throat impedance of an infinite conical horn is

$$z_A = \frac{\rho_0 c}{S_t} \left(\frac{k^2 x_0^2 + jkx_0}{1 + k^2 x_0^2} \right). \quad (7)$$

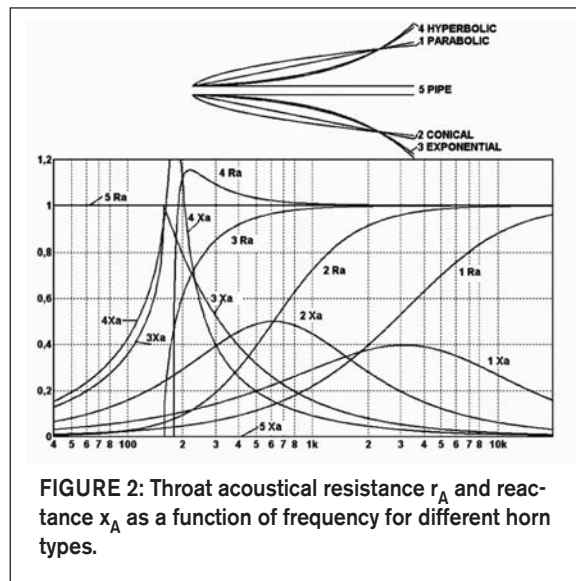

FIGURE 2: Throat acoustical resistance r_A and reactance x_A as a function of frequency for different horn types.

You should note that equation 7 is identical to the expression for the radiation impedance of a pulsating sphere of radius x_0 .

The throat resistance of the conical horn rises slowly (**Fig. 2**). At what frequency it reaches its asymptotic value depends on the solid angle Ω , being lower for smaller solid angle. This means that for good loading at low frequencies, the horn must open up slowly.

As you will see later, a certain minimum mouth area is required to minimize reflections at the open end. This area is larger for horns intended for low frequency use (it depends on the wavelength), which means that a conical horn would need to be very long to provide

satisfying performance at low frequencies. As such, the conical expansion is not very useful in bass horns. Indeed, the conical horn is not very useful at all in applications requiring good loading performance, but it has certain virtues in directivity control.

EXPONENTIAL HORN

Imagine you have two pipes of unequal cross-sectional areas S_0 and S_2 , joined by a third segment of cross-sectional area S_1 , as in **Fig. 3**. At each of the discontinuities, there will be reflections, and the total reflection of a wave passing from S_0 to S_2 will depend on S_1 . It can be shown that the condition for least reflection occurs when

$$S_1 = \sqrt{S_0 S_2}. \quad (8)$$

This means that $S_1 = S_0 k$ and $S_2 = S_1 k$, thus $S_2 = S_0 k^2$. Further expansion along this line gives for the n th segment, $S_n = S_0 k^n$, given that each segment has the same length. If $k = e^m$, and n is replaced by x , you have the exponential horn, where the cross-sectional area of the wave-fronts is given as $S = S_t e^{mx}$. If you assume plane wave-fronts, this is also the cross-sectional area of the horn at a distance x from the throat.

The exponential horn is not a true 1P-horn, so you cannot exactly predict its performance. But much information can be gained from the equations.

The throat impedance of an infinite exponential horn is

$$z_A = \frac{\rho_0 c}{S_t} \left(\sqrt{1 - \frac{m^2}{4k^2}} + j \frac{m}{2k} \right) \quad (9)$$

When $m = 2k$ or $f = \frac{mc}{4\pi}$, the throat resistance becomes zero, and the horn is said to cut off. Below this frequency,

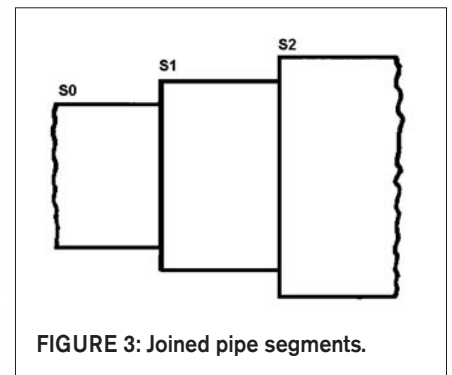

FIGURE 3: Joined pipe segments.

the throat impedance is entirely reactive and is

$$z_A = j \frac{\rho_o c}{S_t} \left(\frac{m}{2k} - \sqrt{\frac{m^2}{4k^2} - 1} \right). \quad (10)$$

The throat impedance of an exponential horn is shown in **Fig. 2**. Above the cutoff frequency, the throat resistance rises quickly, and the horn starts to load the driver at a much lower frequency than the corresponding conical horn. In the case shown, the exponential horn throat resistance reaches 80% of its final value at 270Hz, while the conical horn reaches the same value at about 1200Hz.

An infinite horn will not transmit anything below cutoff, but it's a different matter with a finite horn, as you will see later.

You should note that for an exponential horn to be a real exponential horn, the wave-front areas, not the cross-sectional areas, should increase exponentially. Because the wave-fronts are curved, as will be shown later, the physical horn contour must be corrected to account for this.

HYPERBOLIC HORNS

The hyperbolic horns, also called hyperbolic-exponential or hypex horns, were first presented by Salmon¹⁴, and is a general family of horns given by the wave-front area expansion

$$S = S_t \left(\cosh \frac{x}{x_0} + T \sinh \frac{x}{x_0} \right)^2. \quad (11)$$

T is a parameter that sets the shape of the horn (**Fig. 4**). For T = 1, the horn is an exponential horn, and for T → ∞ the horn becomes a conical horn.

x₀ is the reference distance given as x₀ = $\frac{c}{2\pi f_c}$ where f_c is the cutoff frequency. A representative selection of hypex contours is shown in **Fig. 4**.

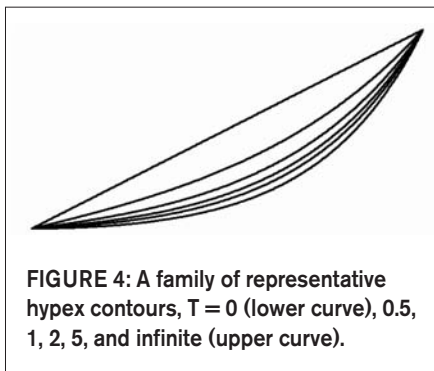

FIGURE 4: A family of representative hypex contours, T = 0 (lower curve), 0.5, 1, 2, 5, and infinite (upper curve).

Above cutoff, the throat impedance of an infinite hyperbolic horn is

$$z_A = \frac{\rho_o c}{S_t} \left(\frac{\sqrt{1 - \frac{1}{\mu^2}}}{1 - \frac{1 - T^2}{\mu^2}} + j \frac{\frac{T}{\mu}}{1 - \frac{1 - T^2}{\mu^2}} \right), \quad (12)$$

and below cutoff, the throat impedance is entirely reactive and is

$$z_A = j \frac{\rho_o c}{S_t} \left(\frac{\frac{1}{\mu} \sqrt{\frac{1}{\mu^2} - 1}}{1 - \frac{1 - T^2}{\mu^2}} \right) \quad (13)$$

where

$$\mu \text{ is the normalized frequency, } \mu = \frac{f}{f_c}.$$

The throat impedance of a hypex horn with T = 0.5 is shown in **Fig. 2**. The throat impedance of a family of horns with T ranging from 0 to 5 is shown in **Fig. 5**.

Exponential and hyperbolic horns have much slower flare close to the throat than the conical horn, and thus have much better low frequency loading. When T < 1, the throat resistance of the hyperbolic horn rises faster to its asymptotic value than the exponential, and for T < √2 it rises above this value right above cutoff. The range 0.5 < T < 1 is most useful when the purpose is to improve loading. When T = 0, there is no reactance component above cutoff for an infinite horn, but the large peak in the throat resistance may cause peaks in the SPL response of a horn speaker.

Due to the slower flaring close to the throat, horns with low values of T will also have somewhat higher distortion than horns with higher T values.

WHAT IS CUTOFF?

Both exponential and hyperbolic horns have a property called cutoff. Below this frequency, the horn transmits nothing, and its throat imped-

ance is purely reactive. But what happens at this frequency? What separates the exponential and hyperbolic horns from the conical horn that does not have a cutoff frequency?

To understand this, you first must look at the difference between plane and spherical waves¹⁰. A plane wave propagating in a uniform tube will not have any expansion of the wave-front. The normalized acoustical impedance is uniform and equal to unity through the entire tube.

A propagating spherical wave, on the other hand, has an acoustical impedance that changes with frequency and distance from the source. At low frequencies and small radii, the acoustical impedance is dominated by reactance. When kr = 1—i.e., when the distance from the source is $\frac{\lambda}{2\pi}$ —the reactive and resistive parts of the impedance are equal, and above this frequency, resistance dominates.

The difference between the two cases is that the air particles in the spherical wave move apart as the wave propagates; the wave-front becomes stretched. This introduces reactance into the system, because you have two components in the propagating wave: the pressure that propagates outward, and the pres-

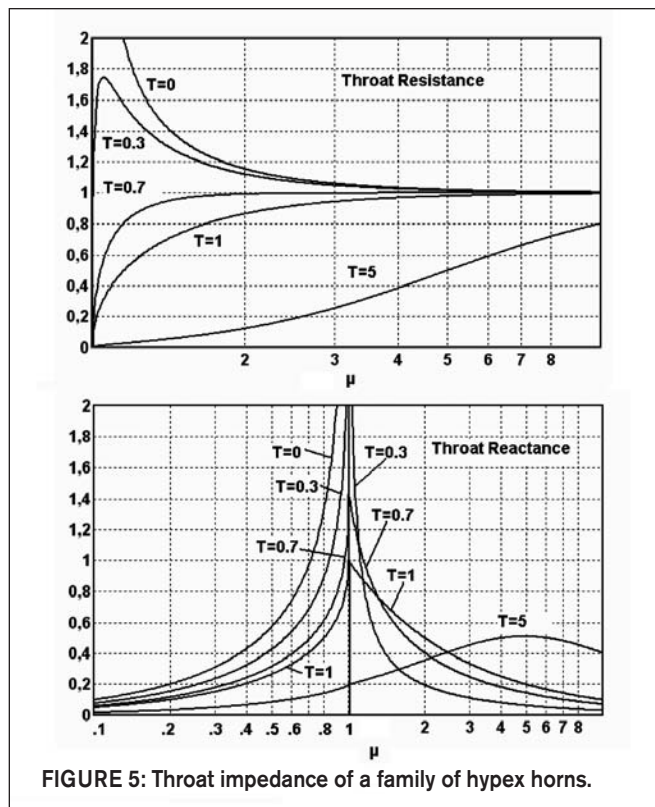

FIGURE 5: Throat impedance of a family of hypex horns.

sure that stretches the wave-front. The propagating pressure is the same as in the non-expanding plane wave, and gives the resistive component of the impedance. The stretching pressure steals energy from the propagating wave and stores it, introducing a reactive component where no power is dissipated. You can say that below $kr = 1$, there is reactively dominated propagation, and above $kr = 1$ there is resistive dominated propagation.

If you apply this concept to the conical and exponential horns by looking at how the wave-fronts expand in these two horns, you will see why the cutoff phenomenon occurs in the exponential horn. You must consider the flare rate of the horn, which is defined as (rate of change of wave-front area with distance)/(wave-front area).

In a conical horn, the flare rate changes throughout the horn, and the point where propagation changes from reactive to resistive changes with frequency throughout the horn.

In an exponential horn, the flare rate is constant. Here the transition from reactive to resistive wave propagation happens at the same frequency throughout the entire horn. This is the cutoff frequency. There is no gradual transition, no frequency dependent change in propagation type, and that's why the change is so abrupt.

FINITE HORNS

For a finite horn, you must consider both parts of equation 3. By solving the horn equation this way^{3, 15}, you get the following results for pressure and volume velocity at the ends of a horn:

$$p_m = ap_t + bU_t \quad (14)$$

$$U_m = fp_t + gU_t \quad (15)$$

where p and U denote the pressure and volume velocity, respectively, and the subscripts denote the throat and mouth of the horn. You can now find the impedance at the throat of a horn, given that you know $a, b, f,$ and g :

$$Z_t = \frac{gZ_m - b}{a - fZ_m} \quad (16)$$

where Z_m is the terminating impedance at the mouth.

The expressions for $a, b, f,$ and g are quite complicated, and are given by Stewart¹⁵ for the uniform tube, the conical, and the exponential horn.

You see that the value of mouth impedance will dictate the value of the throat impedance. As explained previously, there will usually be reflections at the mouth, and depending on the phase and magnitude of the reflected wave, it may increase or decrease the throat impedance. A horn with strong reflections will have large variations in throat impedance.

Reflections also imply standing waves and resonance. To avoid this, it is important to terminate the horn correctly, so that reflections are minimized. This will be discussed in the next section.

It's interesting to see what effect the length has on the performance of a horn. Figure 6 shows the throat impedance of 75Hz exponential horns of different lengths, but the same mouth size. As the horn length increases, the throat resistance rises faster to a useful value, and the peaks in the throat impedance become more closely spaced.

Finite horns will transmit sound below their cutoff frequency. This can be explained as follows: the horn is an acoustical transformer, transforming the high impedance at the throat to a low impedance at the mouth. But this applies only above cutoff. Below cutoff there is no transformer action, and the horn only adds a mass reactance.

An infinite exponential horn can be viewed as a finite exponential horn terminated by an infinite one with the same cutoff. As you have seen, the throat resistance of an infinite exponential horn is zero below cutoff, and the throat resistance of the finite horn will thus be zero. But if the impedance present at the mouth has a non-zero resistance below cutoff, a resistance will be present at the throat. This is illustrated in Fig. 7, where a small exponential horn with a mouth three times larger

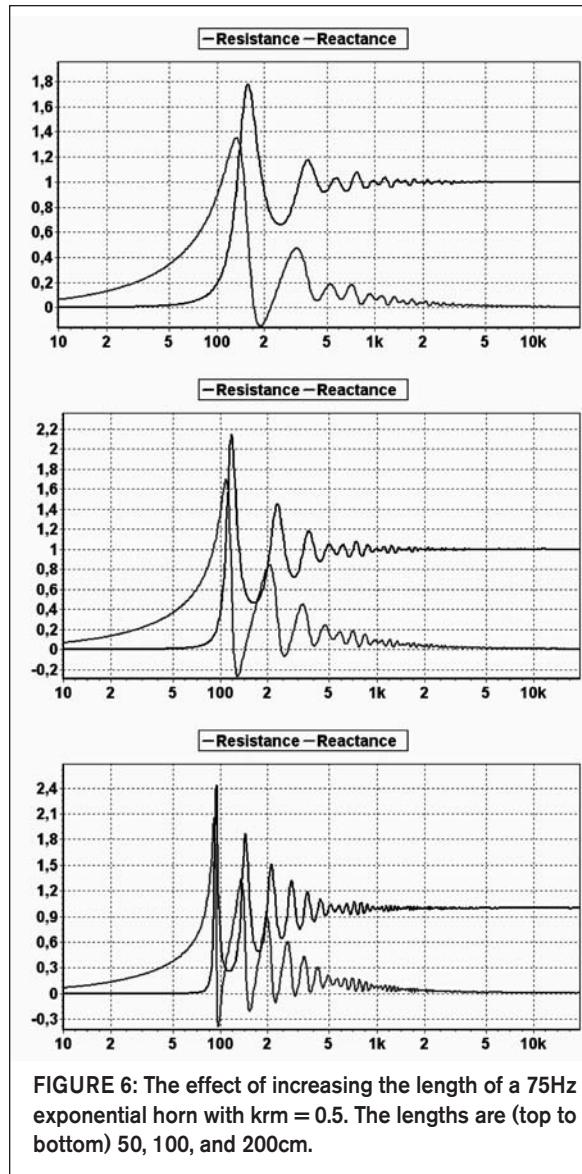

FIGURE 6: The effect of increasing the length of a 75Hz exponential horn with $krm = 0.5$. The lengths are (top to bottom) 50, 100, and 200cm.

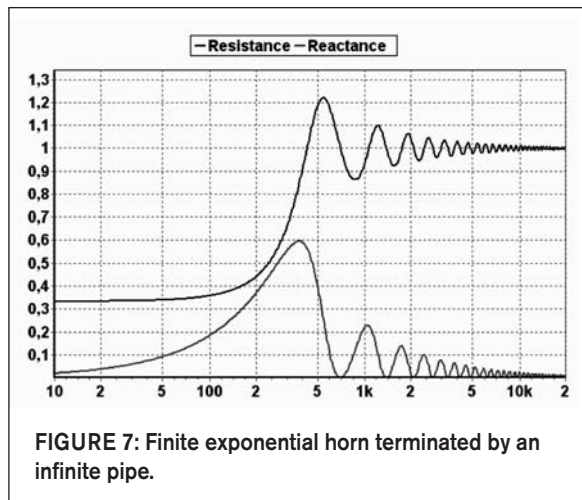

FIGURE 7: Finite exponential horn terminated by an infinite pipe.

than its throat is terminated by an infinite pipe (a pure acoustical resistance). The acoustical resistance present at the throat below cutoff approaches that of the pipe alone, one third of the value above cutoff.

The same is true for any mouth termination. As long as there is a resistive impedance present at the mouth below cutoff, power can be drawn from the horn.

TERMINATION OF THE HORN

I have briefly mentioned that there can be reflections from the mouth of a horn. The magnitude of this reflection depends on frequency and mouth size.

Consider a wave of long wavelength¹⁶. While it is progressing along a tube, it occupies a constant volume, but when it leaves the tube, it expands into an approximate hemispherical shape (Fig. 8). The volume thus increases, the pressure

falls, increasing the velocity of air inside the tube, pulling it out. This produces an impulse that travels backwards from the end of the tube, a reflection.

It's a different matter at higher frequencies. The relative volume of a half-wavelength of sound is much smaller, and the resulting volume increase is less, producing fewer reflections (Fig. 9).

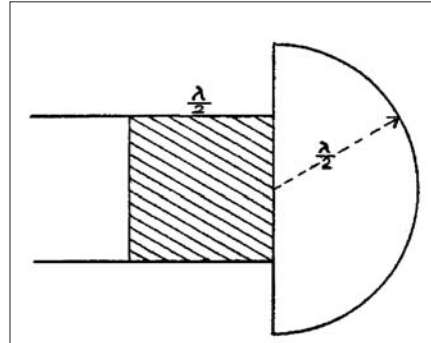

FIGURE 8: Waves with long wavelength at the end of a tube¹⁶.

You may ask what the optimum size of the end of the tube is, to minimize reflection in a certain frequency range. This has been investigated since the early 1920s^{2,5,16,17,18} and has led to the general assumption that if the mouth circumference of an exponential horn is at least one wavelength at the cutoff frequency of the horn, so that $kr_m \geq 1$, the

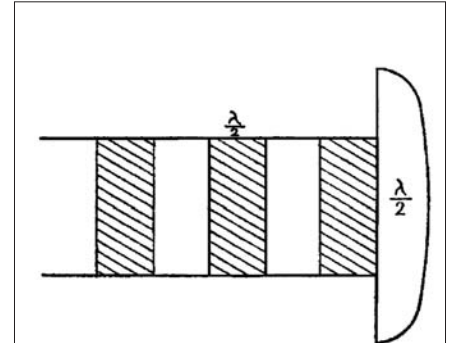

FIGURE 9: Waves with short wavelength at the end of a tube¹⁶.

APPENDIX DERIVATION OF THE WEBSTER HORN EQUATION

This derivation is based on the infinitesimal amplitude, one-parameter plane wave assumption, as discussed in Part 1.

Consider a flaring horn as shown in Fig. A, where dx is the short axial length between two plane wave-fronts of area S . The volume of this element is Sdx , where S is given as an arbitrary function of x . Fluid (air) will flow into this element from one side, and out of it on the other side, due to the passage of sound waves. The change in the mass of the fluid in this volume is

$$-\frac{\partial(\rho S)}{\partial t} dx$$

with dx not changing with time.

The particle velocity of the fluid moving along the x -axis through the element is u , and the difference in the mass of fluid entering one plane and leaving the other, is

$$\rho \frac{\partial(uS)}{\partial x} dx$$

this is ρ (the density of the medium) times the change in volume velocity, uS , with x . Because the fluid is continuous, these two quantities must be equal, so

$$\rho \frac{\partial(uS)}{\partial x} = -\frac{\partial(\rho S)}{\partial t}$$

Expand both sides to get

$$\rho \left(u \frac{\partial S}{\partial x} + S \frac{\partial u}{\partial x} \right) = - \left(\rho \frac{\partial S}{\partial t} + S \frac{\partial \rho}{\partial t} \right)$$

Now introduce the concept of velocity potential, which you can consider as similar to electric potential along a resistive conductor. If this conductor has a resistance R per unit length, the resistance of a small length dx is Rdx . If a current I flows through the conductor, the voltage drop (electrical potential) across dx is

$$\partial U = -RI dx.$$

Setting $R = 1$, you have

$$I = -\frac{\partial U}{\partial x}.$$

Acoustically, you may say that the velocity potential replaces U , and the particle velocity replaces I . Thus $u = -\frac{\partial \phi}{\partial x}$.

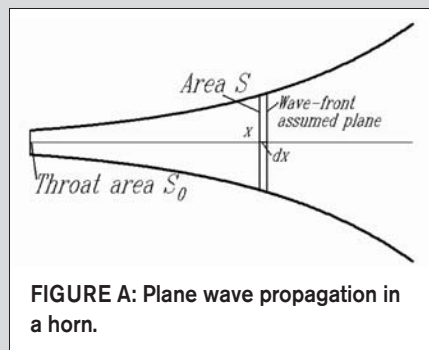

FIGURE A: Plane wave propagation in a horn.

You also have the relation that

$$\frac{\partial \rho}{\partial t} = \rho_0 \frac{\partial s}{\partial t} = \frac{\rho_0}{c^2} \frac{\partial^2 \phi}{\partial t^2},$$

where s is the condensation of the medium, and ρ_0 is the static density of the medium. For infinitesimal amplitudes, $\rho = \rho_0$, and $\frac{\partial A}{\partial t} = 0$, because the area at a given value of x is independent of time. After substitution, you have

$$\frac{\partial^2 \phi}{\partial x^2} + \left[\frac{1}{A} \frac{\partial A}{\partial x} \right] \frac{\partial \phi}{\partial x} - \frac{1}{c^2} \frac{\partial^2 \phi}{\partial t^2} = 0.$$

Because $\frac{1}{S} \frac{\partial S}{\partial x} = \frac{\partial \ln S}{\partial x}$, you can write this as

$$\frac{\partial^2 \phi}{\partial x^2} + \frac{\partial \ln S}{\partial x} \frac{\partial \phi}{\partial x} - \frac{1}{c^2} \frac{\partial^2 \phi}{\partial t^2} = 0$$

This is the fundamental horn equation for infinitesimal amplitudes. If you have simple harmonic motion (a sine or cosine wave of a single frequency), you can write $\phi = \phi_1 \cos \omega t$, which gives $\partial^2 \phi / \partial t^2 = -\omega^2 \phi$, $\omega = 2\pi f$. By using this substitution, and remembering that $k = \omega/c$, you get

$$\frac{d^2 \phi}{dx^2} + \frac{d \ln S}{dx} \frac{d \phi}{dx} - k^2 \phi = 0,$$

which is the most convenient form of the horn equation. ■

reflections will be negligible. r_m is the radius of the mouth.

The effect of different mouth sizes is shown in **Fig. 10**, where the throat impedance of a 100Hz exponential horn is shown. The throat impedance is calculated assuming plane wave-fronts, and using the impedance of a piston in an infinite wall as termination. The mouth sizes correspond to $kr_m = 0.23, 0.46, 0.70,$ and 0.93 . You can see that for higher values of kr_m , the ripple in the throat impedance decreases.

When kr_m is increased beyond 1, however, the ripple increases again, as shown in **Fig. 11**. This led Keele to investigate what the optimum horn mouth size would be¹⁹. For a horn termination simulated by a piston in an infinite baffle, he found the optimum kr_m to be slightly less than 1, the exact value depending on how close to cutoff the horn is operating. His findings were based on the plane wave assumption, which, as you will see in the next section, does not hold in practice.

As a historical side note, Flanders also discovered increased mouth reflections for kr_m larger than 1 for a plane wave exponential horn¹⁸ in 1924.

If the same horn is calculated assuming spherical waves, there is no obvious optimum mouth size. If you consider the throat impedance of two 100Hz horns with $kr_m = 0.93$ and 1.4 , assuming spherical wave-fronts and the same mouth termination as before, you can see that the ripple decreases, not increases, for higher values of kr_m (**Fig. 12**).

The reason may be that the wave-front expansion of a horn where the cross-section is calculated as $S = S_t e^{mx}$ will have a flare rate that decreases toward the mouth. This is because the wave-fronts bulge (**Fig. 13**). The areas of the curved wave-fronts are larger than those of the plane ones, and the distance between them is also larger. But the distance between successive curved

wave-fronts increases faster than their areas, so the outer parts of the horn will have a lower cutoff. The required kr_m for optimum termination becomes large-

er, and it increases as the horn is made longer.

These considerations are valid for exponential horns. What, then, about hyperbolic and conical horns? Hyperbolic horns with $T < 1$ will approximate the exponential horn expansion a certain distance from the throat, and the mouth termination conditions will be similar to those for an exponential horn. Conical horns show no sign of having an optimum mouth size. As length and mouth size increase, simulations show that the throat impedance ripple steadily decreases, and the horn approaches the characteristics of an infinite horn.

In conclusion, you may say that the mouth area of a horn can hardly be made too large, but it can easily be made too small. kr_m in the range 0.7-1 will usually give smooth response for bass horns, while midrange and tweeter horns will benefit from values ≥ 1 .

Another factor you need to consider is the termination at the throat. If there is a mismatch between the driver and the horn, the reflected waves traveling from the mouth will again be reflected when they reach the throat, producing standing waves in the horn.

CURVED WAVE-FRONTS

By logical reasoning, the assumption that the wave-fronts in a horn are plane cannot be true. If it was so, the speed of sound along the horn walls would need to be greater than the speed of sound along the axis. This cannot be the case, and the result is that the wave-front on the axis must gain on that at the horn walls, so the wave-fronts will define convex surfaces. In a circular conical horn the wave-fronts are spherical with centers at the apex. In the uniform tube, the wave-fronts are plane. In both cases the wave-fronts cut the axis and the walls at right angles. It is, therefore, logical to assume that this

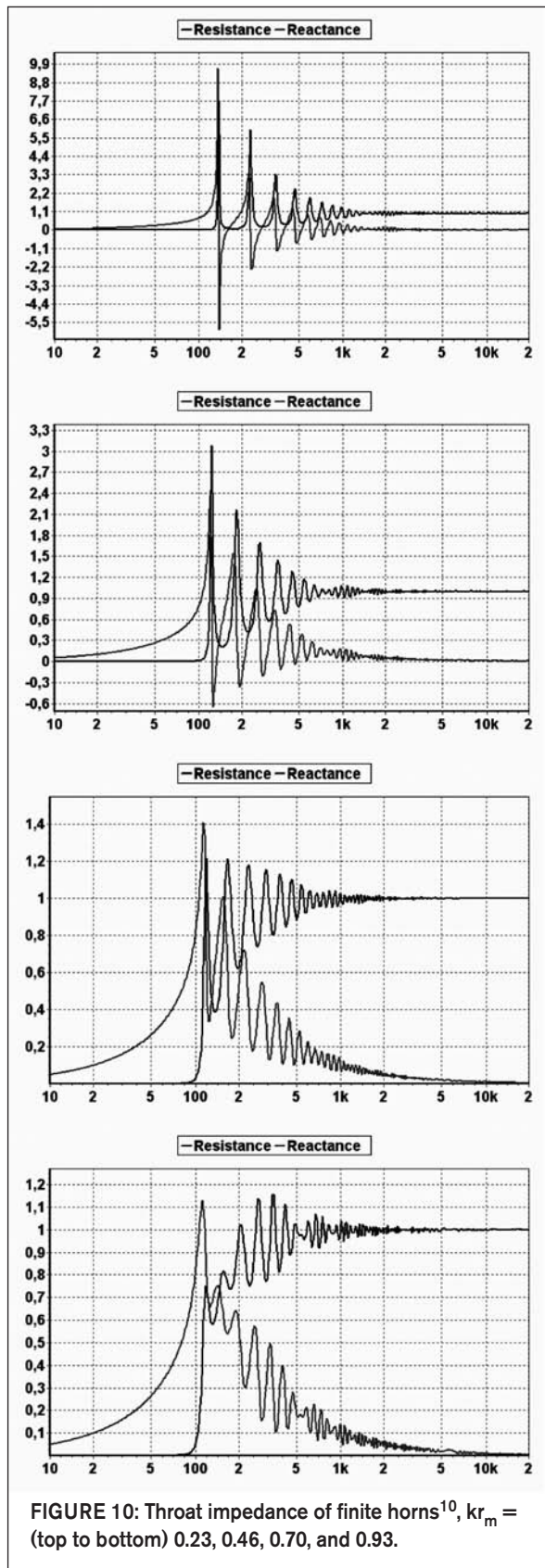

FIGURE 10: Throat impedance of finite horns¹⁰, $kr_m =$ (top to bottom) 0.23, 0.46, 0.70, and 0.93.

will happen in other horn types, too.

WAVE-FRONTS IN HORNS

In 1928, Hall conducted a detailed investigation of the sound field inside horns^{4, 20} showing how the wave-fronts curve in an exponential and a conical horn. The wave-fronts in a 120Hz exponential horn at the cutoff frequency are shown in **Fig. 14**, where you can see that the wave-fronts are very nearly normal to the walls.

It's a different matter at 800Hz (**Fig. 15**). At a certain distance from the throat, the pressure wave-fronts become seriously disturbed. Hall attributes this to reflections at the outer rim of the mouth that are more powerful than at the center, because the discontinuity is greater. Another explanation⁸ is that higher order modes (see Part 2) will distort the shape of the amplitude wave-fronts. This is also most evident in **Fig. 15**. In a flaring horn, higher order modes will not appear at the same frequencies throughout the horn. Close to the throat, where the radius is small, they will appear at fairly high frequencies, but closer to the mouth they will appear at lower frequencies.

Conical horns do not look any better than exponential horns. Hall also investigated a large conical horn, 183cm long, throat diameter 2cm, and mouth diameter 76cm. Simulations show that the horn does not have significant mouth reflections, because the throat impedance is close to that of an infinite horn. Still the amplitude wave-fronts are seriously disturbed, even close to the throat, which does not happen in an exponential horn (**Fig. 16**). You can see two nodal lines, each about halfway between the horn wall and the axis. This is a result of higher order modes, and can be predicted.

The frequency where $R_a = X_a$ —i.e., where the throat acoustical resistance and reactance are equal—is about 1kHz for this horn. This indicates that higher order modes are a problem in conical horns even below the frequency where it has useful loading properties.

TRACTRIX HORN

The tractrix is a kind of horn generated by the revolution of the tractrix curve around the x-axis. The equation for the tractrix curve is given as

$$x = r_m \ln \frac{r_m + \sqrt{r_m^2 - r_x^2}}{r_x} - \sqrt{r_m^2 - r_x^2} \quad (17)$$

where r_m is the mouth radius, usually taken as

$\frac{\lambda_c}{2\pi} = \frac{c}{2\pi f_c}$, where f_c is the horn cutoff frequency, and r_x is the radius of the horn at a distance x from the horn mouth (**Fig. 17**).

Because the radius (or cross-section) is not a function of x , as in most other horns, the tractrix contour is not as straightforward to calculate, but it should not pose any problems.

The tractrix horn expands faster than the exponential horn close to the mouth, as you will see in Part 2.

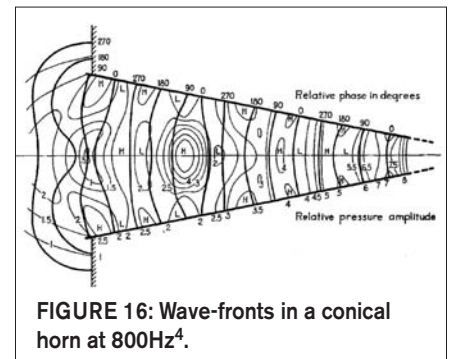
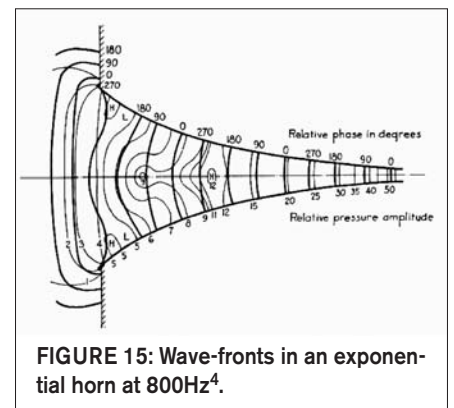
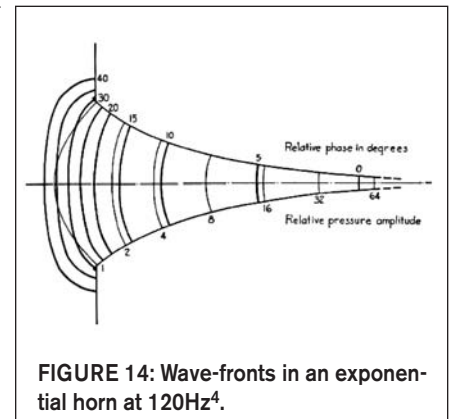
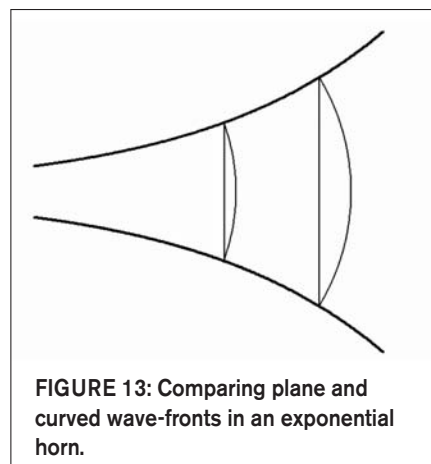
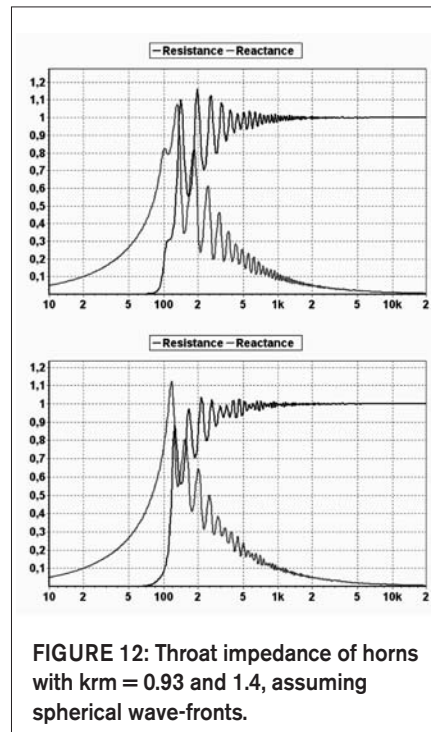
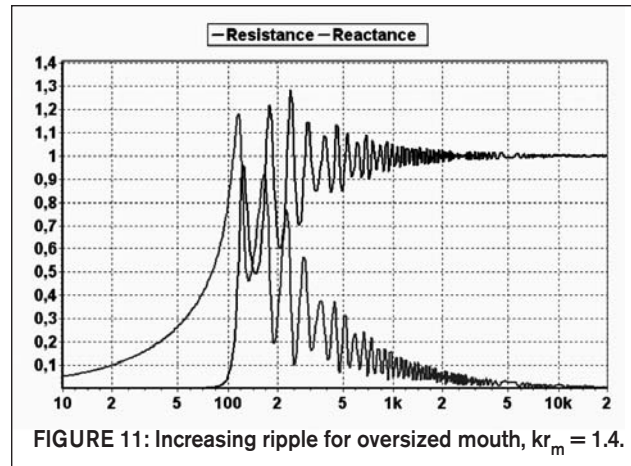

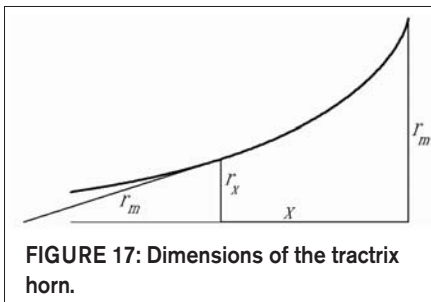

FIGURE 17: Dimensions of the tractrix horn.

The tractrix curve was first employed for horn use by P.G.A.H. Voigt, and patented in 1926²¹. In more recent times it was popularized by Dinsdale²², and most of all by Dr. Bruce Edgar^{23, 24}. The main assumption in the tractrix horn is that the sound waves propagate through the horn as spherical wave-fronts with constant radius, r_m , which also is tangent to the walls at all times (Fig. 18).

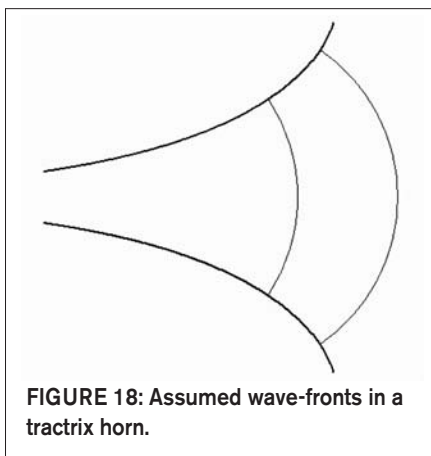

FIGURE 18: Assumed wave-fronts in a tractrix horn.

For this requirement to hold, the wave-front must be spherical at all frequencies, and the velocity of the sound must be constant throughout the horn.

A theory of the tractrix horn was worked out by Lambert²⁵. The throat impedance of a horn was calculated using both a hemisphere and a piston

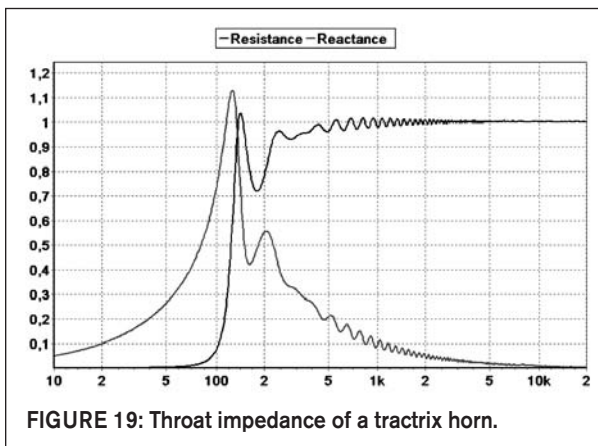

FIGURE 19: Throat impedance of a tractrix horn.

as radiation load, and the results compared to measurements. It appeared that the wave-front at the mouth was neither spherical nor plane. Also, directivity measurements showed increased beaming at higher frequencies. This means that the tractrix horn does not present a hemispherical wave-front at the mouth at all frequencies. It does come close at low frequencies, but so does almost every horn type.

The throat impedance of a 100Hz tractrix horn, assuming wave-fronts in the form of flattened spherical caps and using the radiation impedance of a sphere with radius equal to the mouth radius as mouth termination, is shown in Fig. 19.

Next month Part 2 will continue this in-depth look at various horn types. **ax**

REFERENCES

1. G.K. Behler and M. Makarski, "Two-Port Representation of the Connection between Horn Driver and Horn," *JAES* vol. 51, No. 10, October 2003, pp. 883-897.
2. I.B. Crandall, "Theory of Vibrating Systems and Sound," Van Nostrand, 1926.
3. A.G. Webster, "Acoustical Impedance and the theory of Horns and of the Phonograph," *Proc. N. Ac. of Sci.*, 1919, pp. 275-282.
4. W.M. Hall, "Comments on the Theory of Horns," *JASA* vol 3, 1932, pp. 552-561.
5. N.W. McLachlan, "Loud Speakers," Oxford, 1934.
6. E.R. Geddes, "Acoustic Waveguide Theory," *JAES* Vol. 37, Jul/Aug 1989, pp. 554-569.
7. G.R. Putland, "Every One-parameter Acoustic field Obeys Webster's Horn Equation," *JAES* Vol. 41, No. 6, June 1993, pp. 435-451.
8. A.H. Benade and E.V. Jansson, "On Plane and Spherical Waves in Horns with Nonuniform Flare, Part 1," *Acoustica* vol. 31, 1974, pp. 79-98.

9. J.T. Post and E.L. Hixon, "A Modeling and Measurement Study of Acoustic Horns," dissertation, 1994.

10. K.R. Holland, F.J. Fahy, and C.L. Morfey, "Prediction and Measurement of the One-parameter Behavior of Horns," *JAES* Vol. 39, May 1991, pp. 315-337.

11. H.F. Olson, "Elements of Acoustical Engineering," 2nd edition, Van Nostrand, 1947.

12. AES Information Document, "Plane-Wave Tubes: De-

sign and Practice," *JAES* vol. 39, No. 6. June 1991, pp. 474-480.

13. M. Buck, "Plane Wave Tubes—Uses and Limitations," AES Convention Paper no. 6268, Oct. 2004.

14. V. Salmon, "A New Family of Horns," *JASA* vol. 17, Jan. 1946, pp. 212-218.

15. G.W. Stewart and R.B. Lindsay, "Acoustics," Van Nostrand, 1930.

16. C.R. Hanna and J. Slepian, "The function and design of Horns for Loudspeakers," *Transactions of the AIEE*, 1924.

17. H.C. Harrison, "Improvements in Acoustic Horns," British Patent no. 213 528, 1923/1925.

18. P.B. Flanders, "Improvements in Acoustic Horns," British Patent no. 245 415, 1924/1926.

19. D.B. Keele, "Optimum Horn Mouth Size," AES Preprint no 933, 1973.

20. W.M. Hall, "An investigation of Sound Fields in Regions Restricted by Finite Boundaries," MS Thesis, MIT 1928.

21. P.G.A.H. Voigt, "Improvements in Horns for Acoustic Instruments," British Patent no. 278 098, 1926/1927.

22. J. Dinsdale, "Horn Loudspeaker Design part 1-3," *Wireless World*, March, May, and June 1974.

23. B. Edgar, "The Tractrix Horn Contour," *Speaker Builder* 2/81, pp. 9-15.

24. B. Edgar, "The Edgar Midrange Horn," *Speaker Builder* 1/86, pp. 7-17.

25. R.F. Lambert, "Acoustical studies of the Tractrix Horn part I and II," *JAES* Nov. 1954, pp. 1024-1033.

► Horn Theory: An Introduction, Part 2

By Bjørn Kolbrek

The author continues his look at the various horn types and how they work.

SPHERICAL WAVE HORN

The spherical wave (or Kugelwellen) horn was invented by Klangfilm, the motion picture division of Siemens, in the late 1940s^{26, 27}. It is often mistaken for being the same as the tractrix horn. It's not. But it is built on a similar assumption: that the wave-fronts are spherical with a constant radius. The wave-front area expansion is exponential.

To calculate the spherical wave horn contour, first decide a cutoff frequency f_c and a throat radius y_0 (Fig. 20). The constant radius r_0 is given as

$$r_0 = \frac{c}{\pi f_c} \quad (18)$$

The height of the wave-front at the throat is

$$h_0 = r_0 - \sqrt{r_0^2 - y_0^2} \quad (19)$$

The area of the curved wave-front at the throat is

$$S_0 = 2\pi r_0 h_0$$

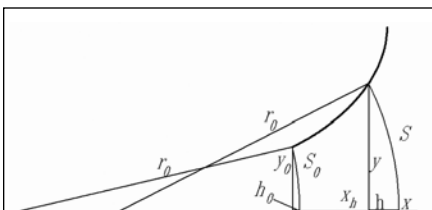

FIGURE 20: Dimensions of a spherical wave horn.

and the area of the wave-front with height h is $2\pi r_0 h$. Thus for the area to increase exponentially, h must increase exponentially:

$$h = h_0 e^{mx} \quad (20)$$

where x is the distance of the top of the wave-front from the top of the throat wave-front and

$$m = \frac{4\pi f_c}{c}$$

Now that you know the area of the wave-front, you can find the radius and the distance of this radius from the origin.

$$S = 2\pi r_0 h$$

$$y = \sqrt{\frac{S}{\pi} - h^2} \quad (21)$$

$$x_h = x - h + h_0 \quad (22)$$

The assumed wave-fronts in a spherical wavehorn are shown in Fig. 21. Notice that the wave-fronts are not assumed to be 90° on the horn walls. Another property of the spherical wave horn is that it can fold back on itself (Fig. 22), unlike the tractrix horn, which is limited to a 90° tangent angle.

The throat impedance of a 100Hz spherical wave horn—assuming wave-fronts in the form of flattened spherical caps and using the radiation impedance of a sphere with radius equal to the mouth radius as mouth termination—is shown in Fig. 23. You can see that it is

not very different from the throat impedance of a tractrix horn.

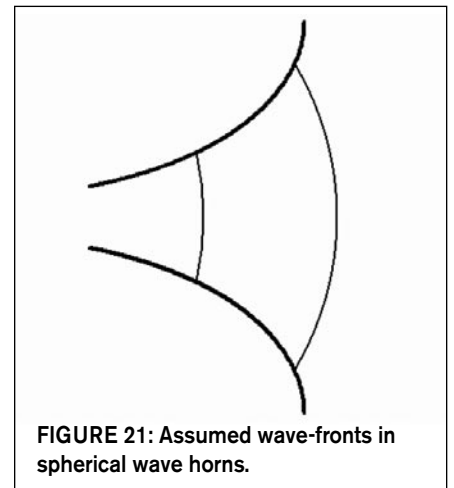

FIGURE 21: Assumed wave-fronts in spherical wave horns.

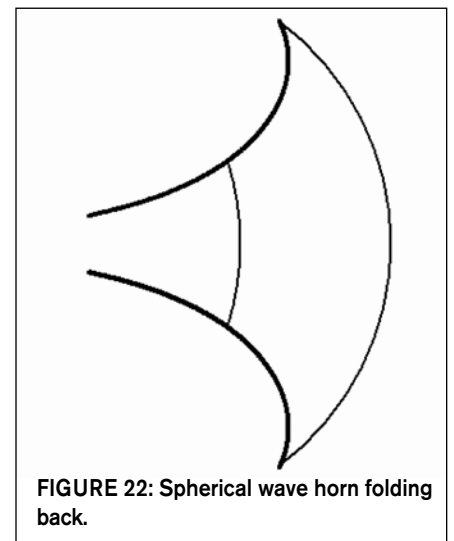

FIGURE 22: Spherical wave horn folding back.

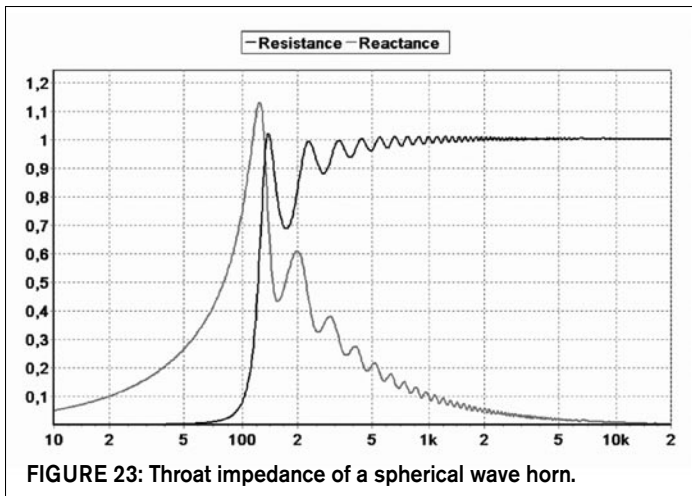

FIGURE 23: Throat impedance of a spherical wave horn.

LE CLÉAC'H HORN

Jean-Michel Le Cléac'h presented a horn that does not rely on an assumed wave-front shape. Rather, it follows a "natural expansion." The principle is shown in Fig. 24. Lines 0-1 show the wave-front surface at the throat (F1). At the point

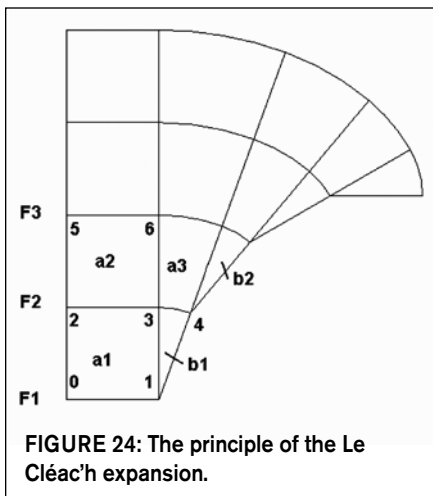

FIGURE 24: The principle of the Le Cléac'h expansion.

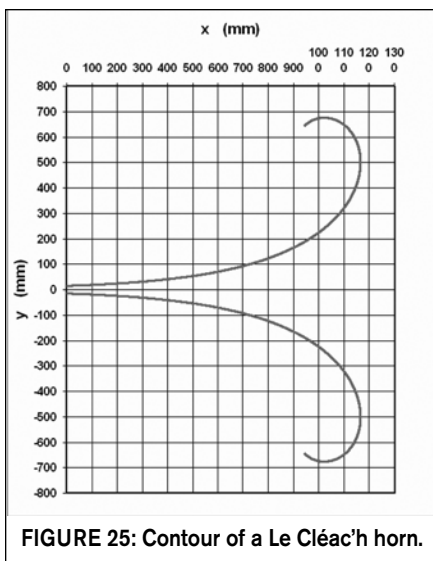

FIGURE 25: Contour of a Le Cléac'h horn.

for further wave expansion at F3. The process is repeated, and the wave-front becomes a curved surface, perpendicular to the axis and the walls, but without making any assumptions regarding the shape prior to the calculations. The wave-fronts are equidistant from each other, and appear to take the shape of flattened spherical caps. The resulting contour of the horn is shown in Fig. 25.

The wave-front expands according to the Salmon family of hyperbolic horns. There is no simple expansion equation for the contour of the Le Cléac'h horn, but you can calculate it with the help of spreadsheets available at <http://ndaviden.club.fr/pavillon/lecleah.html>

OBLATE SPHEROIDAL WAVEGUIDE

This horn was first investigated by Freehafer²⁸, and later independently by Geddes⁶, who wanted to develop a horn suitable for directivity control in which the sound field both inside and outside the horn could be accurately predicted. To do this, the horn needed to be a true 1P-horn. Geddes investigated several coordinate systems, and found the oblate spheroidal (OS) coordinate system to admit 1P waves. Putland⁷ later showed that this was not strictly the case. More work by Geddes²⁹ showed that the oblate spheroidal

it reaches F2, the wave-front area has expanded, and to account for this, a small triangular element (or, really, a sector of a circle) b1 is added.

The wave-front expansion from b1 (line 3-4) continues in element a3, and an element b2 is added to account

waveguide acts like a 1P horn for a restricted frequency range. Above a certain frequency dictated by throat radius and horn angle, there will be higher order modes that invalidate the 1P assumptions.

The contour of the oblate spheroidal waveguide is shown in Fig. 26. It follows the coordinate surfaces in the coordinate system used, but in ordinary Cartesian coordinates, the radius of the horn as a function of x is given as

$$r = \sqrt{r_t^2 + \tan^2(\theta_0)x^2} \quad (23)$$

where

r_t is the throat radius, and θ_0 is half the coverage angle.

The throat acoustical impedance is not given as an analytical function; you must find it by numerical integration. The throat impedance for a waveguide with a throat diameter of 35.7mm and $\theta_0 = 30$ is shown in Fig. 27.

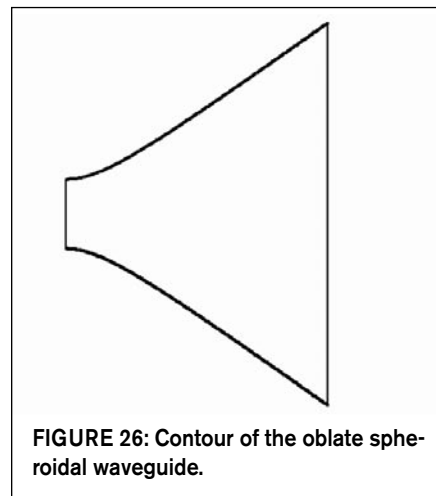

FIGURE 26: Contour of the oblate spheroidal waveguide.

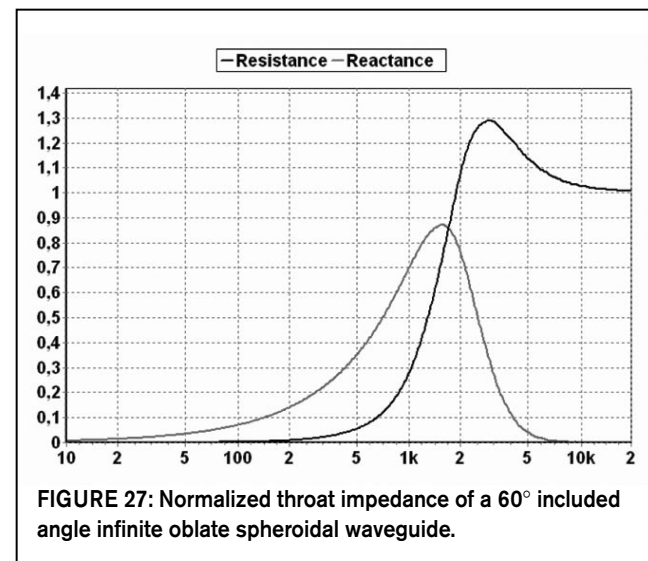

FIGURE 27: Normalized throat impedance of a 60° included angle infinite oblate spheroidal waveguide.

The OS waveguide does not have a sharp cutoff like the exponential or hyperbolic horns, but it is useful to be able to predict at what frequency the throat impedance of the waveguide becomes too low to be useful. If you set this frequency at the point where the throat resistance is 0.2 times its asymptotic value³⁰, so that the meaning of the cutoff frequency becomes similar to the meaning of the term as used with exponential horns, you get

$$f_c = \frac{0.2c \sin \theta_0}{\pi r_t} \quad (24)$$

You see that the cutoff of the waveguide depends on both the angle and the throat radius. For a low cutoff, a larger throat and/or a smaller angle is required. For example, for a 1" driver and 60° included angle ($\theta_0 = 30^\circ$), the cutoff is about 862Hz.

The advantages of the OS waveguide are that it offers improved loading over a conical horn of the same coverage angle, and has about the same directional properties. It also offers a very smooth transition from plane to spherical wave-fronts, which is a good thing, because most drivers produce plane wave-fronts.

The greatest disadvantage of the OS waveguide is that it is not suitable for low-frequency use. Bass and lower mid-range horns based on this horn type will run into the same problems as conical horns: the horns become very long and narrow for good loading.

To sum up, the OS waveguide provides excellent directivity control and fairly good loading at frequencies above about 1kHz.

OTHER HORNS

Three other horn types assuming curved wave-fronts that are worth mentioning are: the Western Electric horns, the Wilson modified exponential, and the Iwata horn. What these horns have in common is that they do not assume curved wave-fronts of constant radius.

The Western Electric type horn¹⁷ uses wave-fronts of constantly increasing radius, all being centered around a vertex a certain distance from the throat (Fig. 29).

In the Wilson modified exponential horn³¹, the waves start out at the throat and become more and more spherical. The horn radius is corrected in an iterative process based on the wall tangent

angle, and the contour lies inside that of the plane-wave exponential horn, being a little longer and with a slightly smaller mouth flare tangent angle (Fig. 28). Unfortunately, the Wilson method only corrects the wave-front areas, not the distance between the successive wave-fronts.

There is not much information available about the Iwata horn^{32, 33}, just a drawing and dimensions, but no description of the concept. It looks like a radial horn, and seems to have cylindrical wave-fronts expanding in area like a hypex-horn with $T = \sqrt{2}$. The ratio of height to width increases linearly from throat to mouth.

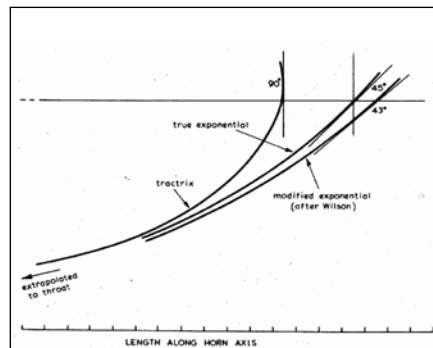

FIGURE 28: Comparison of the exponential horn with the tractrix and the Wilson modified exponential horn²².

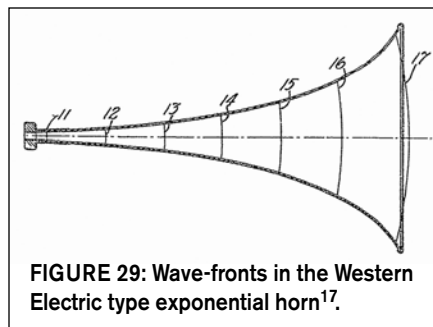

FIGURE 29: Wave-fronts in the Western Electric type exponential horn¹⁷.

DIRECTIVITY CONTROL

Control of directivity is an important aspect of horn design. An exponential horn can provide the driver with uniform loading, but at high frequencies, it starts to beam. It will therefore have a coverage angle that decreases with frequency, which is undesirable in many circumstances. Often you want the horn to radiate into a defined area, spilling as little sound energy as possible in other areas. Many horn types have been designed to achieve this.

For the real picture of the directivity

performance of a horn, you need the polar plot for a series of frequencies. But sometimes you also want an idea of how the coverage angle of the horn varies with frequency, or how much amplification a horn gives. This is the purpose of the directivity factor (Q) and the directivity index (DI)³⁴:

Directivity Factor: The directivity factor is the ratio of the intensity on a given axis (usually the axis of maximum radiation) of the horn (or other radiator) to the intensity that would be produced at the same position by a point source radiating the same power as the horn.

Directivity Index: The directivity index is defined as: $DI(f) = 10 \log_{10} Q(f)$. It indicates the number of dB increase in SPL at the observation point when the horn is used compared to a point source.

Because intensity is watts per square meter, it is inversely proportional to area, and you can use a simple ratio of areas³⁵. Consider a sound source radiating in all directions and observed at a distance r . At this distance, the sound will fill a sphere of radius r . Its area is $4\pi r^2$. The ratio of the area to the area covered by a perfect point source is 1, and thus $Q = 1$. If the sound source is radiating into a hemisphere, the coverage area is cut in half, but the same sound power is radiated, so the sound power per square meter is doubled. Thus $Q = 2$. If the hemisphere is cut in half, the area is 1/4 the area covered by a point source, and $Q = 4$.

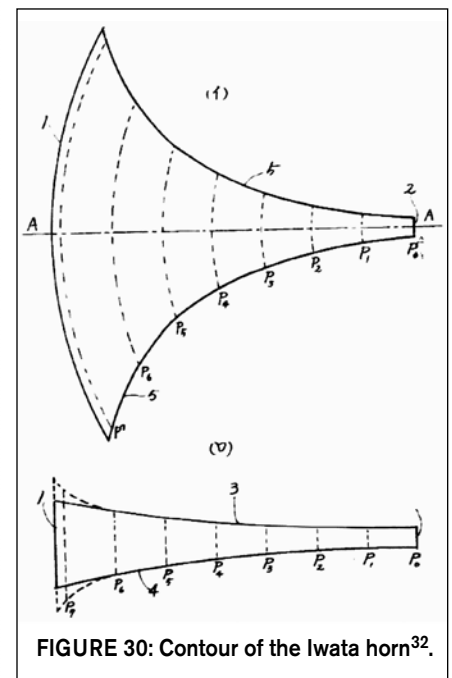

FIGURE 30: Contour of the Iwata horn³².

For a horn with coverage angles α and β as shown in **Fig. 31**, you can compute Q as

$$Q = \frac{180}{\sin^{-1}\left(\sin\frac{\alpha}{2}\sin\frac{\beta}{2}\right)} \quad (25)$$

Most constant directivity horns try to act as a segment of a sphere. A sphere will emit sound uniformly in all directions, and a segment of a sphere will emit sound uniformly in the angle it defines, provided its dimensions are large compared to the wavelength¹¹. But when the wavelength is comparable to the dimensions of the spherical segment, the beam width narrows to 40-50% of its initial value.

A spherical segment can control directivity down to a frequency given as

$$f_1 = \frac{25 \cdot 10^6}{x \cdot \theta} \quad (26)$$

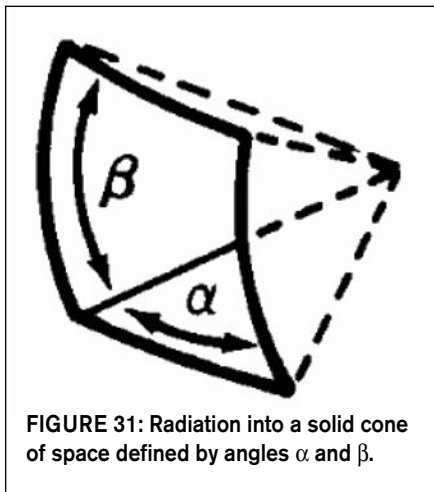

FIGURE 31: Radiation into a solid cone of space defined by angles α and β .

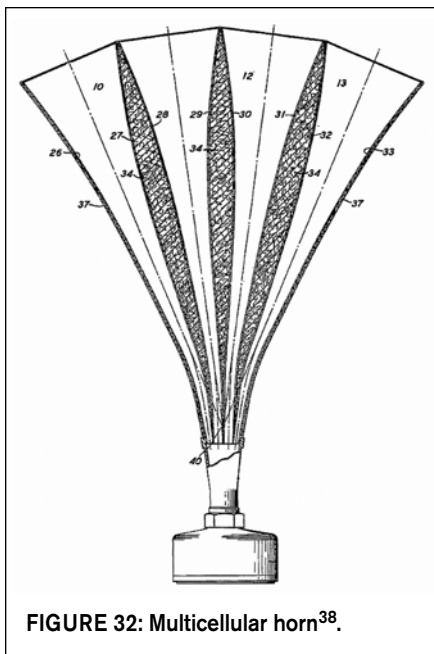

FIGURE 32: Multicellular horn³⁸.

where f_1 is the intercept frequency in Hz where the horn loses directivity control, x is the size of the horn mouth in mm in the plane of coverage, and θ is the desired coverage angle in degrees in that plane.

You thus need a large horn to control directivity down to low frequencies.

Most methods of directivity control rely on simulating a segment of a sphere. The following different methods are listed in historical order.

MULTICELLULAR HORNS

Dividing the horn into many conduits is an old idea. Both Hanna³⁶ and Slepian³⁷ have patented multicellular designs, with the conduits extending all the way back to the source. The source consists of either multiple drivers or one driver with multiple outlets, where each horn is driven from a separate point on the diaphragm.

The patent for the traditional multicellular horn belongs to Edward C. Wentz³⁸. It was born from the need to accurately control directivity, and at the same time provide the driver with proper loading, and was produced for use in the Bell Labs experiment of transmitting the sound of a symphonic orchestra from one concert hall to another³⁹.

A cut view of the multicellular horn, as patented by Wentz, is shown in **Fig. 32**. In this first kind of multicellular horn, the individual horns started almost parallel at the throat, but later designs often used straight horn cells to simplify manufacture of these complex horns. As you can see, the multicellular horn is a cluster of smaller exponential horns, each with a mouth small enough to avoid beaming in a large frequency range, but together they form a sector of a sphere large enough to control directivity down to fairly low frequencies. The cluster acts as one big horn at low frequencies. At higher frequencies, the individual horns start to beam, but because they are distributed on an arc, coverage will still be quite uniform.

The multicellular horn has two problems, however. First, it has the same lower midrange narrowing as the ideal sphere segment, and, second, the polar pattern shows considerably “fingering” at high frequencies. This may not be as serious as has been thought, however. The -6dB

beam widths of a typical multicellular horn are shown in **Fig. 33**. The fingering at high frequencies is shown in **Fig. 34**.

The beam width of a multicellular horn with different number of cells is shown in **Fig. 35**³⁴. The narrowing in beam width where the dimensions of the horn are comparable to the wavelength is evident.

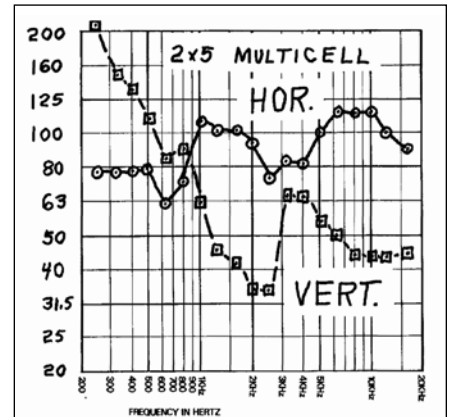

FIGURE 33: -6dB beam widths of Electro-Voice model M253 2 by 5 cell horn⁴².

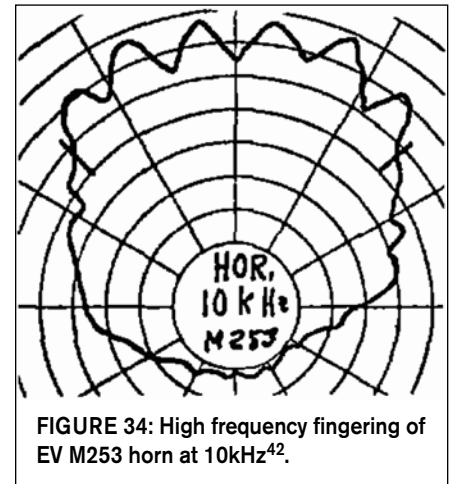

FIGURE 34: High frequency fingering of EV M253 horn at 10kHz⁴².

RADIAL HORNS

The radial or sectoral horn is a much simpler concept than the multicellular horn. The horizontal and vertical views of a radial horn are shown in **Fig. 36**. The horizontal expansion is conical, and defines the horizontal coverage angle of the horn. The vertical expansion is designed to keep an exponential expansion of the wave-front, which is assumed to be curved in the horizontal plane. Directivity control in the horizontal plane is fairly good, but has the same midrange narrowing as the multicellular horn. In

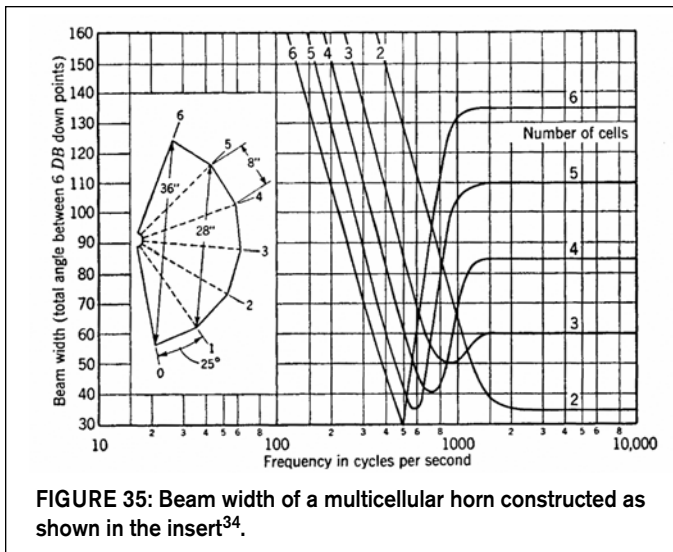

FIGURE 35: Beam width of a multicellular horn constructed as shown in the insert³⁴.

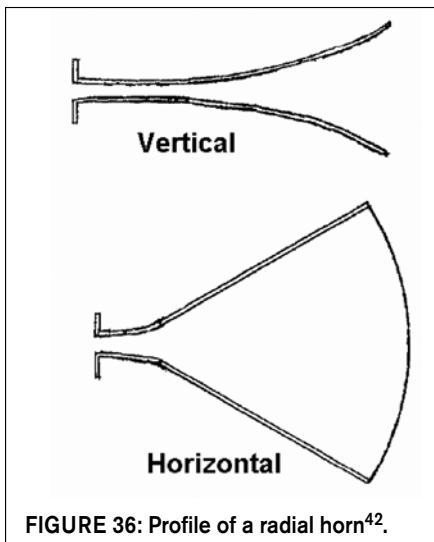

FIGURE 36: Profile of a radial horn⁴².

addition, there is almost no directivity control in the vertical plane, and the beam width is constantly narrowing with increasing frequency.

REVERSED FLARE HORNS

The reversed flare horn can be considered to be a “soft diffraction horn,” contrary to Manta-Ray horns and other modern constant directivity designs that rely on hard diffraction for directivity control. This class of horns was patented for directivity control by Sidney E. Levy and Abraham B. Cohen at University Loudspeakers in the early 1950s^{40, 41}. The same geometry appeared in many Western Electric horns back in the early 1920s, but the purpose does not seem to be that of directivity control¹⁷.

The principle for a horn with good horizontal dispersion is illustrated in Fig. 37. The wave is allowed to expand in the

vertical direction only, then the direction of expansion is changed. The result is that the horizontal pressure that builds up in the first part of the horn causes the wave-front to expand more as it reaches the second part. That it is restricted in the vertical plane helps further.

Because the wave-front expansion is to be exponential all the way, the discontinuity at the flare reversal point (where the expansion changes direction) is small. In addition, the change of curvature at the flare reversal point is made smoother in practical horns than what is shown in the figure.

CE HORNS

In the early 1970s, Keele, then working for Electro-Voice, supplied an answer to the problems associated with multicellular and radial horns by introducing a completely new class of horns that provided both good loading for the driver and excellent directivity control⁴².

The principle is based on joining an exponential or hyperbolic throat segment for driver loading with two conical mouth segments for directivity control. The exponential and conical segments are joined at a point where the conical horn of the chosen solid angle is an optimum termination for the exponential horn. Keele defines this as the point where the radius of the exponential horn is

$$r = \frac{0.95 \sin \theta}{k_c} \quad (27)$$

where

r is the radius at the junction point, θ is the half angle of the cone with solid angle Ω ,

$$\theta = \cos^{-1} \left(1 - \frac{\Omega}{2\pi} \right), \text{ and}$$

k_c is the wave number at the cutoff fre-

quency, $k_c = \frac{2\pi f_c}{c}$.

$$k_c = \frac{2\pi f_c}{c}$$

The problem of midrange narrowing was solved by having a more rapid flare close to the mouth of the conical part of the horn. Good results were obtained by doubling the included angle in the last third of the conical part. This decreases the acoustical source size in the frequency range of midrange narrowing, causing the beam width to widen, and removing the narrowing. The result is a horn with good directivity control down to the fre-

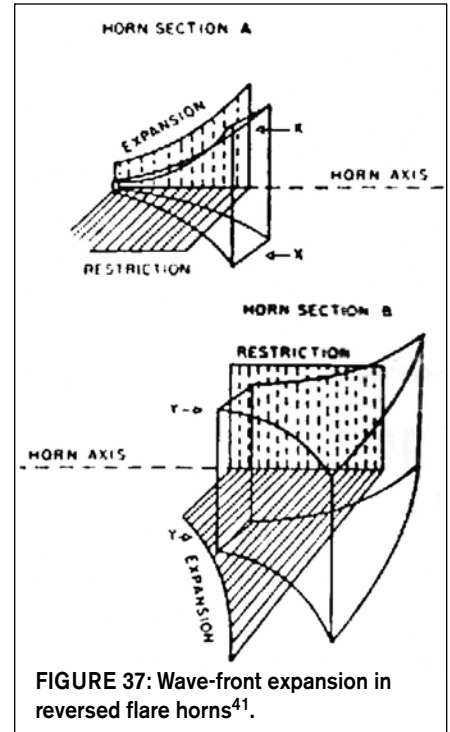

FIGURE 37: Wave-front expansion in reversed flare horns⁴¹.

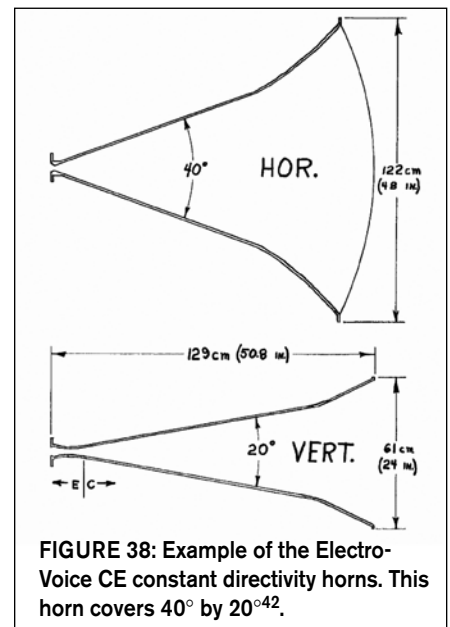

FIGURE 38: Example of the Electro-Voice CE constant directivity horns. This horn covers 40° by 20°⁴².

quency dictated by the mouth size.

For a horn with different horizontal and vertical coverage angles, the width and height of the mouth will not be equal. The aspect ratio of the mouth will be given as

$$R = \frac{X_H}{X_V} = \frac{\sin \frac{\theta_H}{2}}{\sin \frac{\theta_V}{2}}, \quad (28)$$

or, if θ_H and θ_V are limited to 120° ,

$$R \approx \frac{\theta_H}{\theta_V}. \quad (29)$$

The lower frequency of directivity control will also be dictated by the mouth aspect ratio. Substituting equation 26 into equation 29 and solving for the ratio of intercept frequencies, you get

$$\frac{f_{IH}}{f_{IV}} \approx \left(\frac{\theta_H}{\theta_V} \right)^2. \quad (30)$$

For a 40° by 20° (H-V) horn, the vertical intercept frequency will be four times higher than the horizontal intercept frequency.

MANTA-RAY HORNS

The Altec Manta-Ray horn sought to solve the problems of the CE horns, mainly the inability to independently specify the horizontal and vertical intercept frequencies⁴³. To achieve directivity down to a lower frequency in the vertical plane, the vertical dimension of the mouth must be increased. Because the dispersion angle is smaller, the expansion must start further back, behind where the horizontal expansion starts. The result is the unique geometry shown in **Fig. 39** (although it's not so unique anymore).

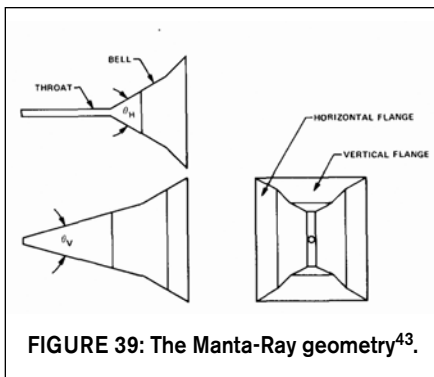

FIGURE 39: The Manta-Ray geometry⁴³.

At the point where the horizontal expansion starts, the wave is diffracted to fill the width of the horn, and dispersion is controlled by the horn walls.

The Manta-Ray horn incorporates the same rapid mouth flaring as the CE horns to avoid midrange narrowing, but does not use radial expansion of the walls. The reason for this is that radial walls produced a “waist-banding” effect, in which the horn lost much energy out to the sides in the upper midrange. This effect cannot be seen in the polar plots for the CE horns, which suggests that “waist-banding” can be a result of the Manta-Ray geometry, and not solely of radial wall contours.

NEW METHODS

Most newer constant directivity designs have been based on either the conical horn, some sort of radial horn (including the JBL Biradial design), or diffraction methods such as the Manta-Ray design. The only notable exception is the oblate spheroidal waveguide (covered previously) introduced by Geddes.

The general trend in horns designed for directivity control has been to focus on the control issue, because it is always possible to correct the frequency response. A flat frequency response does not, however, guarantee a perfect impulse response, especially not in the presence of reflections. Reflected waves in the horn at the high levels in question will also cause the resulting horn/driver combination to produce higher distortion than necessary, because the driver is presented with a nonlinear and resonant load. (See next section.)

DISTORTION

As mentioned, the horn equation is derived assuming that the pressure variations are infinitesimal. For the intensities appearing at the throat of horns, this assumption does not hold. Poisson showed in 1808 that, generally, sound waves cannot be propagated in air without change in form, resulting in the generation of distortion, such as harmonics and intermodulation products. The distortion is caused by the inherent nonlinearity of air.

If equal positive and negative increments of pressure are impressed on a mass of air, the changes in volume of that mass will not be equal. The volume change for positive pressure will be less than that for the equal negative pressure⁴⁴. You can get an idea of the na-

ture of the distortion from the adiabatic curve for air (**Fig. 40**). The undisturbed pressure and specific volume of air ($\frac{1}{\rho}$)

is indicated in the point P_0V_0 . Deviation from the tangent of the curve at this point will result in the generation of unwanted frequencies, the peak of the wave being stretched and the trough compressed.

The speed of sound is given as

$$c = \sqrt{\gamma \frac{P}{\rho}} \quad (31)$$

where

γ is the adiabatic constant of air, $\gamma = 1.403$.

You can see that the speed of sound increases with increasing pressure. So for the high pressure at the peaks of the wave-front, the speed of sound is higher than at the troughs. The result is that as the wave propagates, the peaks will gain on the troughs, altering the shape of the waveform and introducing harmonics (**Fig. 41**).

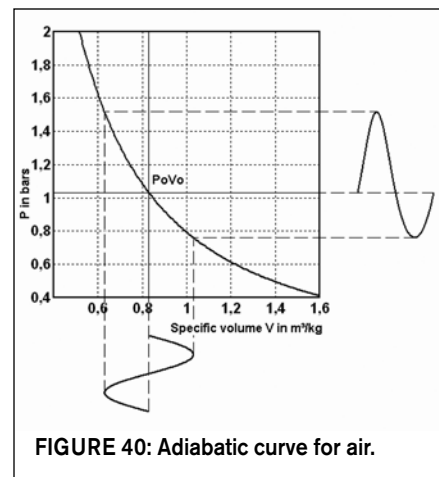

FIGURE 40: Adiabatic curve for air.

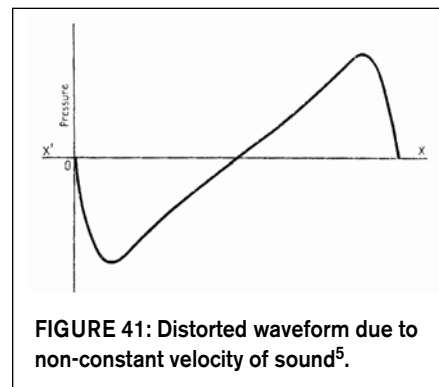

FIGURE 41: Distorted waveform due to non-constant velocity of sound⁵.

There are thus two kinds of distortion of a sound wave: one because of the unequal alteration of volume, and another because of the propagation itself. This

last kind of distortion is most noticeable in a plane wave and in waves that expand slowly, as in horns, where distortion increases with the length propagated. Both kinds of distortion generate mainly a second harmonic component.

Fortunately, as the horn expands, the pressure is reduced, and the propagation distortion reaches an asymptotic value, which can be found for the horn in question, considering how it expands. It will be higher for a horn that expands slowly near the throat than for one that expands rapidly. For example, a hyperbolic-exponential horn with a low value for T will have higher distortion than a conical horn. For an exponential horn, the pressure ratio of second harmonic to fundamental is given as⁴⁴

$$\frac{p_2}{p_1} = \frac{\gamma + 1}{2\sqrt{2}} \frac{p_{1t}}{\gamma p_0} \frac{\omega}{c} \frac{e^{-mx/2}}{m/2} \quad (32)$$

where

p_{1t} is the RMS pressure of the fundamental at the throat,

p_1 is the RMS pressure of the fundamental at x ,

p_2 is the RMS pressure of the second harmonic at x ,

p_0 is the static pressure of air, and

m is the flare rate of the exponential horn.

You can see that distortion increases with frequency relative to the cutoff frequency. This is easier to see in the simplification for an infinite exponential horn given by Beranek³⁴:

$$D_2[\%] = 1.73 \cdot 10^{-2} \frac{f}{f_c} \sqrt{I_t} \quad (33)$$

where

I_t is the intensity at the throat, in watts per square meter.

Holland et al.⁴⁵ have investigated the distortion generated by horns both with the use of a computer model and by measurements. The model considered the harmonics required at the throat to generate a pure sine wave at the mouth (backward modeling), and also took reflections from the mouth into account. For a horn with a 400Hz cutoff and 4" throat, and a mouth SPL of 150dB, the distribution of harmonics is shown in **Fig. 42**. The peak of the cutoff frequency is due to the very high level required at the throat to generate the required SPL at the mouth.

Figure 43 shows the level of the harmonics at the throat at 1kHz for a given SPL at the mouth. Measurements showed that the prediction of the second harmonic level was quite accurate, but measured levels of the higher harmonics were higher than predicted. This was recognized as being due to nonlinearities in the driver.

As you can see from the results, the level of harmonics is quite low at the levels usually encountered in the home listening environment, but can be quite considerable in the case of high-level public address and sound reinforcement systems.

One point I need to mention is the importance of reducing the amount of reflection to reduce distortion. At the high levels involved, the reflected wave from diffraction slots or from the mouth will not combine with the forward propagating wave in a linear manner. The result will be higher distortion, and a nonlinear load for the driver. A driver working into a nonlinear load will not perform at its best, but will produce higher distortion levels than it would under optimum loading conditions⁴⁵.

Directivity of the horn also plays a role in the total distortion performance⁴⁶. If the horn does not have constant directivity, the harmonics, because they are higher in frequency, will be concentrated toward the axis, while the fundamental spreads out more. This means that distortion will be higher on-axis than off-axis.

HIGHER ORDER MODES

At low frequencies, you can consider wave transmission in most horns as one-dimensional (1P waves). When the wavelength of sound becomes comparable to the dimensions of the horn, however, cross reflections can occur. The mode of propagation changes from the simple fundamental mode to what is called higher order modes. The behavior of these modes can be predicted for the uniform pipe and the conical horn^{47, 48, 49}, and it is found that they have cutoff frequencies below which they do not occur.

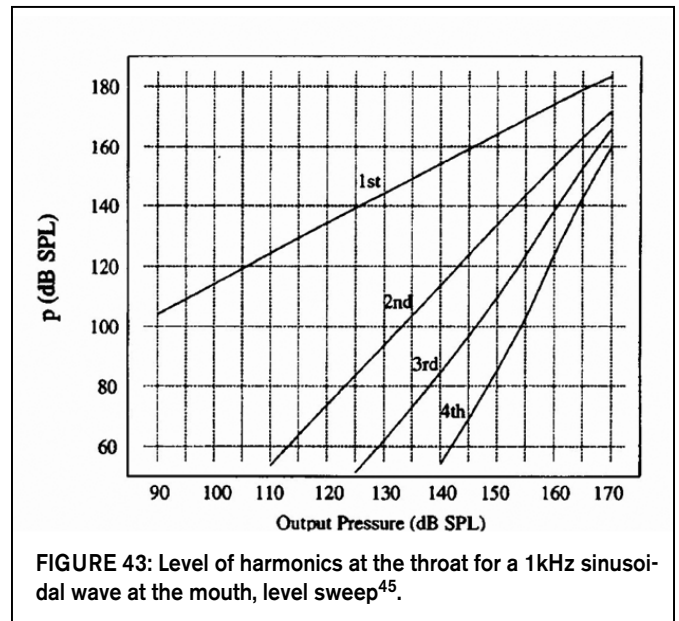
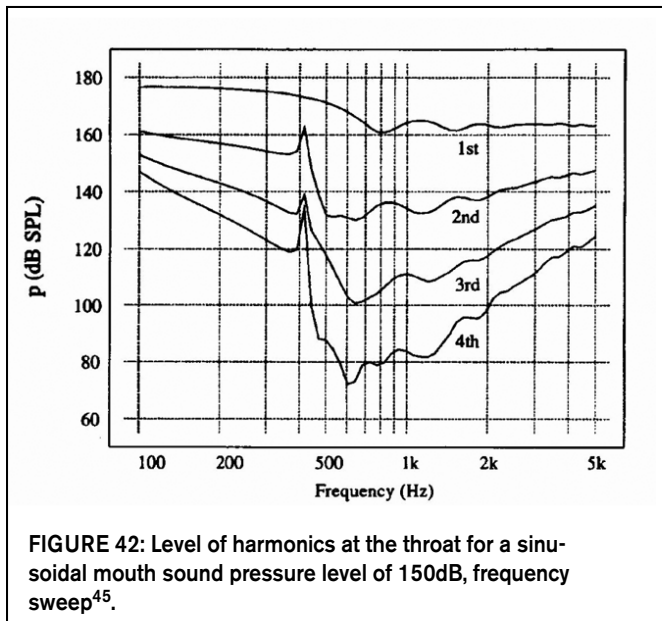

In 1925, Hoersch conducted a theoretical study of higher order modes in a conical horn, and calculated the equipressure contours for two kinds of modes. The results (Fig. 44) show the equipressure contours including both the radial and non-radial vibrations. The left part of the figure shows a pattern that resembles what Hall measured in a conical horn (Fig. 16). For a flaring horn such as the exponential, however, the higher order modes will occur at different frequencies at different places in the horn⁸.

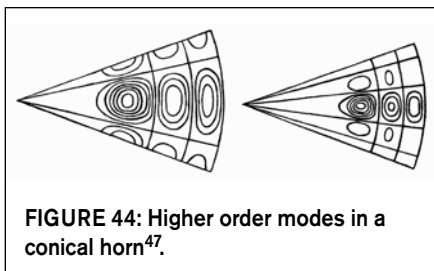

FIGURE 44: Higher order modes in a conical horn⁴⁷.

Higher order modes will also be generated by rapid changes in flare, such as discontinuities, so the smoother the horn curvature changes, the less the chance for generating higher order modes.

The effect of the higher order modes is to disturb the shape of the pressure wave-front, so that directivity will be unpredictable in the range where the modes occur. According to Geddes, they may also have a substantial impact on the perceived sound quality of horns⁵⁰.

CLOSING REMARKS

In this article, I have tried to present both classical and modern horn theory in a comprehensive way. A short article like this can never cover all aspects of horns. But I hope it has provided useful information about how horns work, maybe also shedding light on some lesser known aspects and research.

Finally, I would like to thank Thomas Dunker and David McBean for proof-reading, discussion, and suggestions.

ax

REFERENCES

26. Klangfilm GmbH, "Lautsprecher mit Exponentialtrichter," Swiss Patent no. 279947, 1948/1951.
 27. H. Schmidt, "Über eine neuartige Lautsprecherkombination," Funk und Ton no. 5, 1950, pp. 226-232.
 28. J.E. Freehafer, "The Acoustical Impedance of

an Infinite Hyperbolic Horn," JASA vol. 11, April 1940, pp. 467-476.

29. E.R. Geddes, "Acoustic Waveguide Theory Revisited," JAES Vol. 41, No. 6, June 1993, pp.452-461.

30. D. Mapes-Riordan, "Horn Modeling with Conical and Cylindrical Transmission-Line Elements," JAES Vol. 41, No. 6, June 1993, pp. 471-484.

31. P. Wilson and G. Webb: "Modern Gramophones and Electrical Reproducers," Cassell and Company Ltd, 1929.

32. N. Iwata, Jap. patent no 54-59129, 1979.

33. J. Hiraga, *Les Haut-Parleurs*, 3rd edition, Dunod 2000.

34. L. Beranek, *Acoustics*, McGraw-Hill, 1954.

35. "Notes on Loudspeaker Directivity," Altec Technical Letter no. 211.

36. C.R. Hanna, "Multiple Inlet Horn," US Patent no. 1 715 706, 1925/1929.

37. J. Slepian, "Sound-Generating Device," US Patent no. 1 684 975, 1926/1928.

38. E.C. Wenthe, "Acoustic Device," US Patent no. 1 992 268, 1933/1935.

39. E.C. Wenthe and A.L. Thuras, "Loud Speakers and Microphones," BSTJ April 1934, pp. 259-277.

40. S.E. Levy and A.B. Cohen, "Acoustic Device," US Patent no. 2 690 231, 1950/1954.

41. A.B. Cohen, "Wide Angle Dispersion of High-Frequency Sound," *Audio Engineering*, Dec. 1952, pp. 24-25, 57-59.

42. D.B. Keele, "What's so Sacred About Exponential Horns?," AES preprint no. 1038, 1975.

43. C.A. Henricksen and M.S. Ureda, "The Manta-Ray Horns," JAES Vol. 26, No. 9, Sept. 1978, pp. 629-634.

44. A.L. Thuras, R.T. Jenkins, H.T. O'Neil, "Extraneous Frequencies Generated in Air Carrying Intense Sound Waves," BSTJ Jan. 1935, pp. 159-172.

45. K. Holland and C. L. Morfey, "A Model of Nonlinear Propagation in Horns," JAES Vol. 44, No. 7/8, Jul/Aug 1996, pp. 569-580.

46. T. Kikkawa, A. Yukiyoishi, and N. Sakamoto, "A New Horn Loudspeaker Design yields low Distortion and wide Dispersion," AES preprint no. 1151, 1976.

47. V.A. Hoersch, "Non-radial Vibrations Within a Conical Horn," *Physical Review*, Feb. 1925, pp. 218-224.

48. P.M. Morse and K.U. Ingard, "Theoretical Acoustics," 1968.

49. W.P. Mason, "Electromechanical Transducers and Wave Filters," Van Nostrand, 1942.

50. L.W. Lee and E.R. Geddes, "Audibility of Linear Distortion with Variations in Sound Pressure Level and Group Delay," AES Convention Paper no. 6888, Oct. 2006.